

## 12 *transfers*

Transfers are ideal for the Hotfix application on all kinds of textiles. They are available in a large range of motives and rows, which are made up of different articles of the Flat Backs Hotfix assortment. Featuring designs from the in-house design team, they can comprise XILION Roses, Ringed XILION Roses or Creation Stones, as well as Metallics and Crystaltex Motives.

Transfers are also available as No Hotfix version, to be glued onto any material.

The offered Transfers motives are divided in three categories: Standard Collection, Trend Collections and Special Collections to suit all needs in the targeted segments such as women's wear, sports & casual wear, children's wear etc.

*flat backs*  
COLOURS & EFFECTS

## Colours

	Crystal 001		Montana 207		Mocca 286		Crystal Volcano 001 VOL
	White Opal 234		Capri Blue 243		Sand Opal* 287		White Opal Sky Blue***** 234 SBL
	Vintage Rose 319		Sapphire 206		Light Grey Opal 383		Crystal Meridian Blue 001 MBL
	Light Rose 223		Light Sapphire 211		Greige 284		Crystal Metallic Blue 001 METBL
	Rose 209		Air Blue Opal 285		Black Diamond 215		Crystal Sage 001 SAG
	Indian Pink 289		Aquamarine 202		Jet 280		Crystal Tabac 001 TAB
	Fuchsia 502		Pacific Opal 390		Light Multi*** 908		Crystal Metallic Light Gold 001 MLGLD
	Ruby 501		Caribbean Blue Opal 394		Rainbow Multi**** 909		Crystal Dorado 001 DOR
	Padparadscha 542		Blue Zircon 229	Effects			Jet Nut 280 NUT
	Sun 248		Chrysolite 238				Crystal Aurore Boreale 001 AB
	Fireopal* 237		Peridot 214		Jonquil Aurore Boreale 213 AB		Crystal Cosmojet* 001 COS
	Hyacinth 236		Fern Green 291		Topaz Aurore Boreale 203 AB	Hotfix Transparent	
	Light Siam 227		Erinite 360		Light Rose Aurore Boreale 223 AB		
	Indian Siam* 327		Emerald 205		Light Siam Aurore Boreale 227 AB		Crystal Transmission Hotfix Transparent 001 TRA HFT
	Siam 208		Palace Green Opal 393		Jet Aurore Boreale 280 AB		Mint Alabaster Hotfix Transparent 397 HFT
	Dark Siam* 308		Olivine 228		Blue Zircon Satin 229 SAT		Crystal Frosted 001 FRO
	Burgundy 515		Khaki 550		Sapphire Satin 206 SAT		Crystal Frosted Aurore Boreale 001 FRO AB
	Light Amethyst 212		Citrine 249		Light Siam Satin 227 SAT		Chalkwhite Nacre** 279 NAC
	Provence Lavender 283		Light Topaz 226		Smoked Topaz Satin 220 SAT		Crystal Nacre 001 NAC
	Tanzanite 539		Jonquil 213		Jonquil Satin 213 SAT		Chalkwhite Creampearl*** 279 CPL
	Cyclamen Opal 398		Silk 391		Crystal Moonlight 001 MOL		Crystal Creampearl 001 CPL
	Amethyst 204		Light Peach 362		Crystal Silver Shade 001 SSHA		Jet 280
	Purple Velvet 277		Light Colorado Topaz 246		Crystal Golden Shadow 001 GSHA		Jet Hematite 280 HEM
	Dark Indigo 288		Topaz 203		Crystal Copper 001 COP		
	Cobalt 369		Smoked Topaz 220		Crystal Red Magma 001 REDM		

Classic Colours

Exclusive Colours



## Numerical Order

001	Crystal	203	Topaz	229	Blue Zircon	289	Indian Pink
001 AB	Crystal Aurore Boreale	203 AB	Topaz Aurore Boreale	229 SAT	Blue Zircon Satin	291	Fern Green
001 COP	Crystal Copper	204	Amethyst	234	White Opal	308	Dark Siam*
001 COS	Crystal Cosmojet*	205	Emerald	234 SBL	White Opal Sky Blue*****	319	Vintage Rose
001 CPL	Crystal Creampearl	206	Sapphire	236	Hyacinth	327	Indian Siam*
001 DOR	Crystal Dorado	206 SAT	Sapphire Satin	237	Fireopal*	360	Erinite
001 FRO	Crystal Frosted	207	Montana	238	Chrysolite	362	Light Peach
001 FRO AB	Crystal Frosted Aurore Boreale	208	Siam	243	Capri Blue	369	Cobalt
001 GSHA	Crystal Golden Shadow	209	Rose	246	Light Colorado Topaz	383	Light Grey Opal
001 HFT	Crystal Hotfix Transparent*	211	Light Sapphire	248	Sun	390	Pacific Opal
001 MBL	Crystal Meridian Blue	212	Light Amethyst	249	Citrine	391	Silk
001 METBL	Crystal Metallic Blue	213	Jonquil	277	Purple Velvet	393	Palace Green Opal
001 METGLD	Crystal Metallic Light Gold	213 AB	Jonquil Aurore Boreale	279 CPL	Chalkwhite Creampearl**	394	Caribbean Blue Opal
001 MLGLD	Crystal Metallic Light Gold	213 SAT	Jonquil Satin	279 NAC	Chalkwhite Nacre**	397 HFT	Mint Alabaster Hotfix Transparent
001 MOL	Crystal Moonlight	214	Peridot	280	Jet		
001 NAC	Crystal Nacre	215	Black Diamond	280 AB	Jet Aurore Boreale	398	Cyclamen Opal
001 REDM	Crystal Red Magma	220	Smoked Topaz	280 HEM	Jet Hematite	501	Ruby
001 SAG	Crystal Sage	220 SAT	Smoked Topaz Satin	280 NUT	Jet Nut	502	Fuchsia
001 SSHA	Crystal Silver Shade	223	Light Rose	283	Provence Lavender	515	Burgundy
001 TAB	Crystal Tabac	226	Light Topaz	284	Greige	539	Tanzanite
001 TRA HFT	Crystal Transmission Hotfix Transparent	227	Light Siam	285	Air Blue Opal	542	Padparadscha
001 VOL	Crystal Volcano	227 AB	Light Siam Aurore Boreale	286	Mocca	550	Khaki
202	Aquamarine	227 SAT	Light Siam Satin	287	Sand Opal*	908	Light Multi****
		228	Olivine	288	Dark Indigo	909	Rainbow Multi*****

## Alphabetical Order

<a href="#">Air Blue Opal (285)</a>	<a href="#">Crystal Meridian Blue (001 MBL)</a>	<a href="#">Jet (280)</a>	<a href="#">Pacific Opal (390)</a>
<a href="#">Amethyst (204)</a>	<a href="#">Crystal Metallic Blue (001 METBL)</a>	<a href="#">Jet Aurore Boreale (280 AB)</a>	<a href="#">Padparadscha (542)</a>
<a href="#">Aquamarine (202)</a>	<a href="#">Crystal Metallic Light Gold (001 MLGLD)</a>	<a href="#">Jet Hematite (280 HEM)</a>	<a href="#">Palace Green Opal (393)</a>
<a href="#">Black Diamond (215)</a>	<a href="#">Crystal Moonlight (001 MOL)</a>	<a href="#">Jet Nut (280 NUT)</a>	<a href="#">Peridot (214)</a>
<a href="#">Blue Zircon (229)</a>	<a href="#">Crystal Nacre (001 NAC)</a>	<a href="#">Jonquil (213)</a>	<a href="#">Purple Velvet (277)</a>
<a href="#">Blue Zircon Satin (229 SAT)</a>	<a href="#">Crystal Red Magma (001 REDM)</a>	<a href="#">Jonquil Aurore Boreale (213 AB)</a>	<a href="#">Rainbow Multi***** (909)</a>
<a href="#">Burgundy (515)</a>	<a href="#">Crystal Sage (001 SAG)</a>	<a href="#">Jonquil Satin (213 SAT)</a>	<a href="#">Rose (209)</a>
<a href="#">Capri Blue (243)</a>	<a href="#">Crystal Silver Shade (001 SSHA)</a>	<a href="#">Khaki (550)</a>	<a href="#">Provence Lavender (283)</a>
<a href="#">Caribbean Blue Opal (394)</a>	<a href="#">Crystal Tabac (001 TAB)</a>	<a href="#">Light Amethyst (212)</a>	<a href="#">Ruby (501)</a>
<a href="#">Chalkwhite Creampearl** (279 CPL)</a>	<a href="#">Crystal Transmission Hotfix Transparent (001 TRA HFT)</a>	<a href="#">Light Colorado Topaz (246)</a>	<a href="#">Sand Opal* (287)</a>
<a href="#">Chalkwhite Nacre** (279 NAC)</a>	<a href="#">Crystal Volcano (001 VOL)</a>	<a href="#">Light Grey Opal (383)</a>	<a href="#">Sapphire (206)</a>
<a href="#">Chrysolite (238)</a>	<a href="#">Cyclamen Opal (398)</a>	<a href="#">Light Multi*** (908)</a>	<a href="#">Sapphire Satin (206 SAT)</a>
<a href="#">Citrine (249)</a>	<a href="#">Dark Indigo (288)</a>	<a href="#">Light Peach (362)</a>	<a href="#">Siam (208)</a>
<a href="#">Cobalt (369)</a>	<a href="#">Dark Siam* (308)</a>	<a href="#">Light Rose (223)</a>	<a href="#">Silk (391)</a>
<a href="#">Crystal (001)</a>	<a href="#">Emerald (205)</a>	<a href="#">Light Sapphire (211)</a>	<a href="#">Smoked Topaz (220)</a>
<a href="#">Crystal Aurore Boreale (001 AB)</a>	<a href="#">Erinite (360)</a>	<a href="#">Light Siam (227)</a>	<a href="#">Smoked Topaz Satin (220 SAT)</a>
<a href="#">Crystal Copper (001 COP)</a>	<a href="#">Fern Green (291)</a>	<a href="#">Light Siam Aurore Boreale (227 AB)</a>	<a href="#">Sun (248)</a>
<a href="#">Crystal Cosmojet* (001 COS)</a>	<a href="#">Fireopal* (237)</a>	<a href="#">Light Siam Satin (227 SAT)</a>	<a href="#">Tanzanite (539)</a>
<a href="#">Crystal Creampearl (001 CPL)</a>	<a href="#">Fuchsia (502)</a>	<a href="#">Light Topaz (226)</a>	<a href="#">Topaz (203)</a>
<a href="#">Crystal Dorado (001 DOR)</a>	<a href="#">Greige (284)</a>	<a href="#">Mint Alabaster Hotfix Transparent (397 HFT)</a>	<a href="#">Topaz Aurore Boreale (203 AB)</a>
<a href="#">Crystal Frosted (001 FRO)</a>	<a href="#">Hyacinth (236)</a>	<a href="#">Mocca (286)</a>	<a href="#">Vintage Rose (319)</a>
<a href="#">Crystal Frosted Aurore Boreale (001 FRO AB)</a>	<a href="#">Indian Pink (289)</a>	<a href="#">Montana (207)</a>	<a href="#">White Opal (234)</a>
<a href="#">Crystal Golden Shadow (001 GSHA)</a>	<a href="#">Indian Siam* (327)</a>	<a href="#">Olivine (228)</a>	<a href="#">White Opal Sky Blue***** (234 SBL)</a>
<a href="#">Crystal Hotfix Transparent* (001 HFT)</a>			

Classic Colours: This colour range offers a wide choice of traditional Swarovski crystal colours.

Exclusive Colours: This colour range is offered exclusively by Swarovski.

Slight changes in shades are unavoidable.

\* Only available in limited sizes.

\*\* While stock last!

\*\*\* Light Multi consists of Crystal, Peridot, Crystal Aurore Boreale, Jonquil and Light Sapphire.

\*\*\*\* Rainbow Multi consists of Topaz, Light Siam, Fuchsia, Peridot and Sapphire.

\*\*\*\*\* White Opal Sky Blue is only available as special production.

## *product charts*

OVERVIEW OF ALL AVAILABLE ARTICLES FOR TRANSFERS INCL. SC-OFFICE CODES.

Flat Backs Hotfix

<<<

2000 Rose

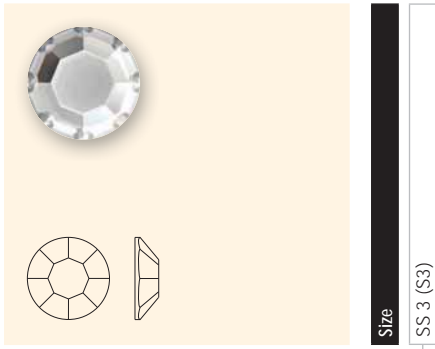

Colour		Size
	Crystal M HF (001)	SS 3 (S3)
	Crystal AB M HF (001 AB)	
	Jet M HF (280)	
	Aquamarine M HF (202)	
	Black Diamond M HF (215)	
	Dark Siam M HF (308)	
	Indian Siam M HF (327)	
	Light Colorado Topaz M HF (246)	
	Light Rose M HF (223)	
	Montana M HF (207)	
	Smoked Topaz M HF (220)	

Ringed Roses

<<<

2029 Ringed Roses

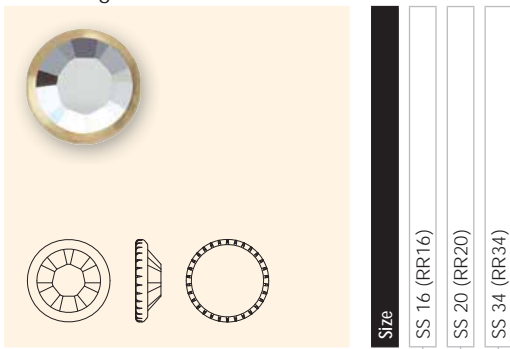

Colour		Size
	Crystal Gold-ringed (001 GR)	SS 16 (RR16) SS 20 (RR20) SS 34 (RR34)
	Crystal Silver-ringed (001 SR)	
	Crystal AB Gold-ringed (001 AB GR)	
	Crystal AB Silver-ringed (001 AB SR)	
	Jet Gold-ringed (280 GR)	
	Jet Silver-ringed (280 SR)	
	Jet Hematite Gold-ringed (280 HEM GR)	
	Jet Hematite Silver-ringed (280 HEM SR)	
	Light Siam Gold-ringed (227 GR)	SS 16 (RR16) SS 20 (RR20) SS 34 (RR34)
	Light Siam Silver-ringed (227 SR)	

Creation Stones

<<<

2035 Chessboard Circle

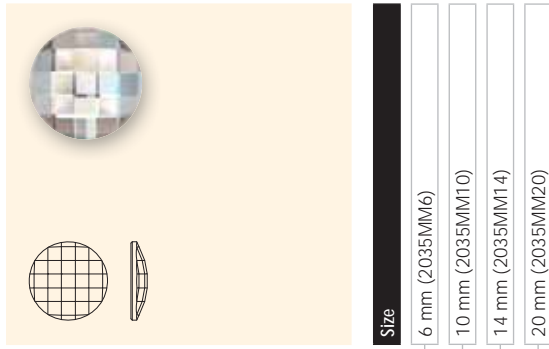

Size  
6 mm (2035MM6)  
10 mm (2035MM10)  
14 mm (2035MM14)  
20 mm (2035MM20)

Colour	6 mm (2035MM6)	10 mm (2035MM10)	14 mm (2035MM14)	20 mm (2035MM20)
Crystal M HF (001)	■	■	■	■
Crystal AB M HF (001 AB)	■	■	■	■
Crystal Dorado M HF (001 DOR)	■	■	■	■
Crystal Golden Shadow M HF (001 GSHA)	■	■	■	■
Crystal Red Magma M HF (001 REDM)	■	■	■	■
Crystal Silver Shade M HF (001 SSHA)	■	■	■	■
Jet M HF (280)	■	■	■	■
Aquamarine M HF (202)	■	■	■	■
Black Diamond M HF (215)	■	■	■	■
Peridot M HF (214)	■	■	■	■
Topaz M HF (203)	■	■	■	■

2200 Navette Flat Back

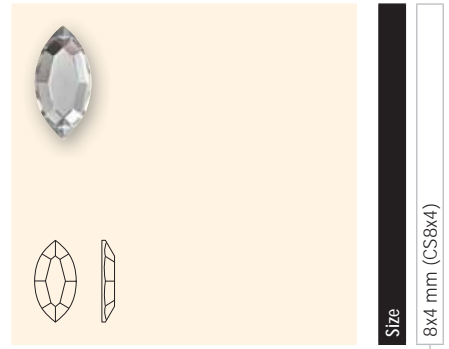

Size  
8x4 mm (CS8x4)

Colour	8x4 mm (CS8x4)
Crystal M HF (001)	■
Crystal AB M HF (001 AB)	■
Jet M HF (280)	■
Jet Hematite M HF (280 HEM)	■

2180/4

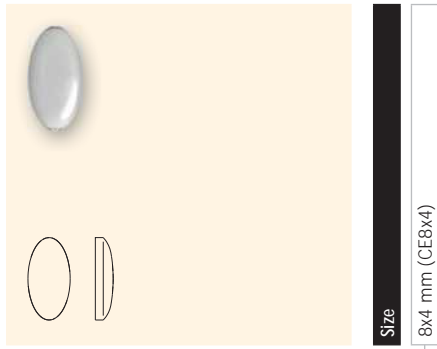

Size  
8x4 mm (CE8x4)

Colour	8x4 mm (CE8x4)
Crystal M HF (001)	■
Crystal AB M HF (001 AB)	■
Jet M HF (280)	■
Jet Hematite M HF (280 HEM)	■

2300 Drop Flat Back

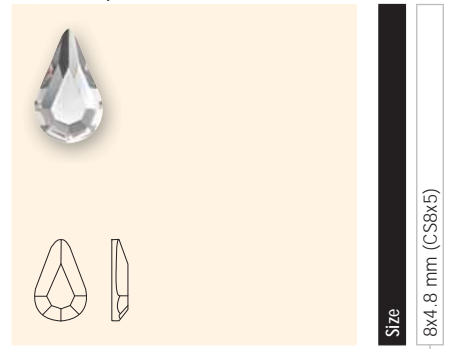

Size  
8x4.8 mm (CS8x5)

Colour	8x4.8 mm (CS8x5)
Crystal M HF (001)	■
Crystal AB M HF (001 AB)	■
Jet M HF (280)	■
Jet Hematite M HF (280 HEM)	■



2400 Square Flat Back

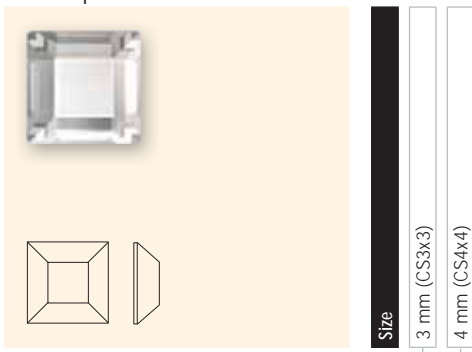

Size  
3 mm (CS3x3)  
4 mm (CS4x4)

Colour	
	Crystal M HF (001)
	Crystal AB M HF (001 AB)
	Crystal Copper M HF (001 COP)
	Crystal Golden Shadow M HF (001 GSHA)
	Crystal Silver Shade M HF (001 SSHA)
	Jet M HF (280)
	Jet Hematite M HF (280 HEM)
	Aquamarine M HF (202)
	Light Rose M HF (223)
	Light Siam M HF (227)

2493 Chessboard Flat Back

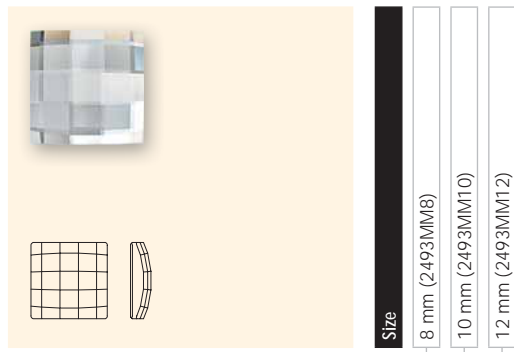

Size  
8 mm (2493MM8)  
10 mm (2493MM10)  
12 mm (2493MM12)

Colour	
	Crystal M HF (001)
	Crystal AB M HF (001 AB)
	Crystal Copper M HF (001 COP)
	Crystal Golden Shadow M HF (001 GSHA)
	Crystal Silver Shade M HF (001 SSHA)
	Jet M HF (280)
	Aquamarine M HF (202)
	Black Diamond M HF (215)
	Light Rose M HF (223)
	Light Siam M HF (227)

2510 Baguette Flat Back

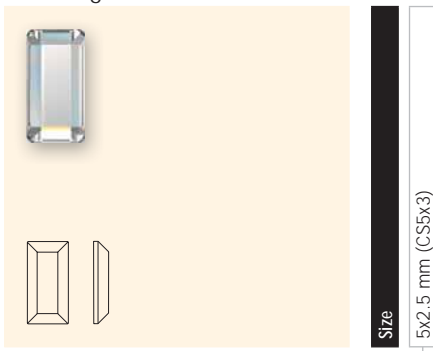

Size  
5x2.5 mm (CS5x3)

Colour	
	Crystal M HF (001)
	Crystal AB M HF (001 AB)
	Jet M HF (280)
	Jet Hematite M HF (280 HEM)

2512/3\*

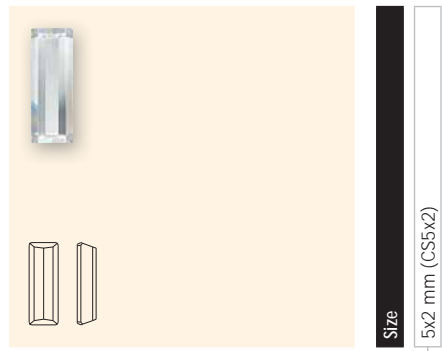

Size  
5x2 mm (CS5x2)

Colour	
	Crystal M HF (001)
	Crystal AB M HF (001 AB)
	Jet M HF (280)
	Jet Hematite M HF (280 HEM)

\* Art. 2512/3 is only available in Transfers.

2555 Cosmic Baguette Flat Back

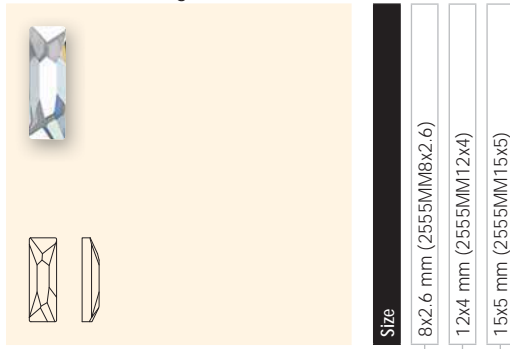

Colour	8x2.6 mm (2555MM8x2.6)	12x4 mm (2555MM12x4)	15x5 mm (2555MM15x5)
Crystal M HF (001)	■	■	■
Crystal AB M HF (001 AB)	■	■	■
Crystal Copper M HF (001 COP)	■	■	■
Crystal Golden Shadow M HF (001 GSHA)	■	■	■
Crystal Silver Shade M HF (001 SSHA)	■	■	■
Jet M HF (280)	■	■	■
Aquamarine M HF (202)	■	■	■
Light Rose M HF (223)	■	■	■
Light Siam M HF (227)	■	■	■

2610 Rectangle Flat Back

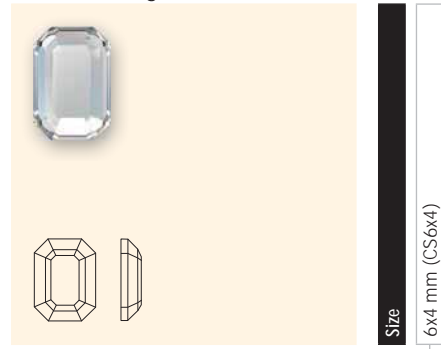

Colour	6x4 mm (CS6x4)
Crystal M HF (001)	■
Crystal AB M HF (001 AB)	■
Jet M HF (280)	■
Jet Hematite M HF (280 HEM)	■

2711 Triangle Flat Back

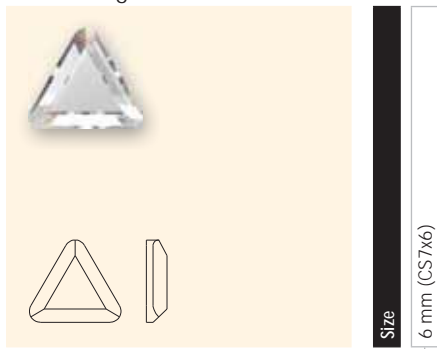

Colour	6 mm (CS7x6)
Crystal M HF (001)	■
Crystal AB M HF (001 AB)	■
Jet M HF (280)	■
Jet Hematite M HF (280 HEM)	■

2720 Cosmic Delta Flat Back

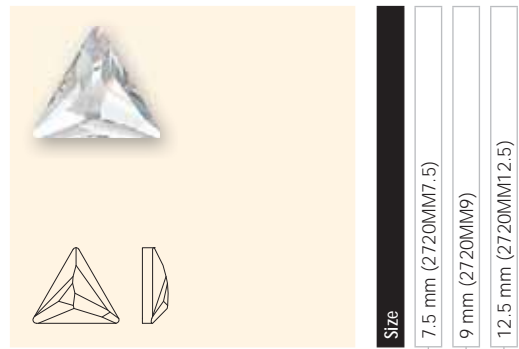

Colour	7.5 mm (2720MM7.5)	9 mm (2720MM9)	12.5 mm (2720MM12.5)
Crystal M HF (001)	■	■	■
Crystal AB M HF (001 AB)	■	■	■
Crystal Copper M HF (001 COP)	■	■	■
Crystal Golden Shadow M HF (001 GSHA)	■	■	■
Crystal Silver Shade M HF (001 SSHA)	■	■	■
Jet M HF (280)	■	■	■
Aquamarine M HF (202)	■	■	■
Light Rose M HF (223)	■	■	■
Light Siam M HF (227)	■	■	■
Smoked Topaz M HF (220)	■	■	■

2728 Marguerite Flat Back

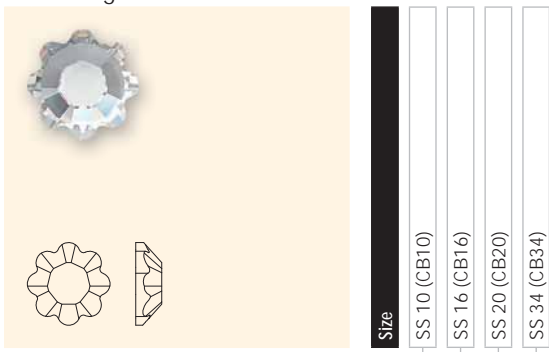

Colour	SS 10 (CB10)	SS 16 (CB16)	SS 20 (CB20)	SS 34 (CB34)
Crystal M HF (001)	■	■	■	■
Crystal AB M HF (001 AB)	■	■	■	■

2770 Wing Flat Back



Colour	6x3.5 mm (2770MM6x3.5)	12x7 mm (2770MM12x7)	16x9.5 mm (2770MM16x9.5)
Crystal M HF (001)	■	■	■
Crystal AB M HF (001 AB)	■	■	■
Crystal Copper M HF (001 COP)	■	■	■
Crystal Golden Shadow M HF (001 GSHA)	■	■	■
Crystal Silver Shade M HF (001 SSHA)	■	■	■
Jet M HF (280)	■	■	■

2797 Diamond Leaf Flat Back

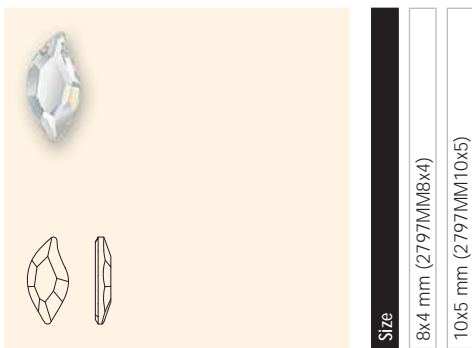

Colour	8x4 mm (2797MM8x4)	10x5 mm (2797MM10x5)
Crystal M HF (001)	■	■
Crystal AB M HF (001 AB)	■	■
Crystal Copper M HF (001 COP)	■	■
Crystal Golden Shadow M HF (001 GSHA)	■	■
Crystal Silver Shade M HF (001 SSHA)	■	■
Jet M HF (280)	■	■
Jet Nut M HF (280 NUT)	■	■
Aquamarine M HF (202)	■	■
Light Amethyst M HF (212)	■	■
Light Rose M HF (223)	■	■
Light Siam M HF (227)	■	■
Light Topaz M HF (226)	■	■
Mocca M HF (286)	■	■
Olivine M HF (228)	■	■

Aquamarine M HF (202)	■	■	■
Black Diamond M HF (215)	■	■	■
Light Amethyst M HF (212)	■	■	■
Light Rose M HF (223)	■	■	■
Light Siam M HF (227)	■	■	■
Light Topaz M HF (226)	■	■	■
Provence Lavender M HF (283)	■	■	■
Smoked Topaz M HF (220)	■	■	■

Pearls

<<<

2080/4

	SS 10 (P3)	SS 16 (P4)	SS 34 (P7)
<b>Size</b>			
<b>Colour</b>			
Crystal Creampearl M HF (001 CPL)	■	■	■
Crystal Frosted M HF (001 FRO)	■	■	■
Crystal Frosted AB M HF (001 FRO AB)	■	■	■
Crystal Nacre M HF (001 NAC)	■	■	■
Jet M HF (280)	■	■	■
Jet Hematite M HF (280 HEM)	■	■	■
Chalkwhite Creampearl M HF (279 CPL)*	■	■	■
Chalkwhite Nacre M HF (279 NAC)*	■	■	■

\* while stock last



Diamonds

<<<

1360

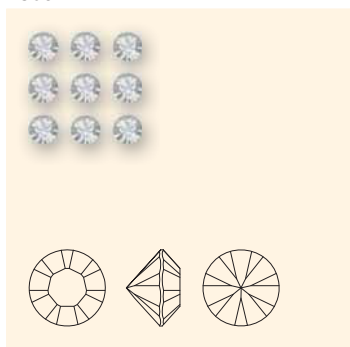

Size	PP 7 (PP7)	PP 12 (PP12)	PP 17 (PP17)
------	------------	--------------	--------------























Colour

Crystal (001)	■	■	■
Crystal AB (001 AB)	■	■	■
Crystal Copper (001 COP)	■	■	■
Crystal Metallic Blue (001 METBL)	■	■	■
Crystal Silver Shade (001 SSHA)	■	■	■
Jet (280)	■	■	■
Amethyst (204)	■	■	■
Aquamarine (202)	■	■	■
Dark Indigo (288)	■	■	■
Emerald (205)	■	■	■
Fern Green (291)	■	■	■
Indian Pink (289)	■	■	■
Light Colorado Topaz (246)	■	■	■
Light Peach (362)	■	■	■
Light Rose (223)	■	■	■
Light Sapphire (211)	■	■	■
Light Siam (227)	■	■	■
Mocca (286)	■	■	■
Padparadscha (542)	■	■	■
Peridot (214)	■	■	■
Provence Lavender (283)	■	■	■
Sapphire (206)	■	■	■
Siam (208)	■	■	■
Smoked Topaz (220)	■	■	■
Tanzanite (539)	■	■	■
Topaz (203)	■	■	■
Vintage Rose (319)	■	■	■

Transfers

**Metallics**

<<<

	3490 3490/006 (M2*)		3490 3490/008 (M8)		3490 3490/002 (M10x3)
	3490 3490/012 (M2.5*)		3490 3490/009 (MZ8*)		3490 3490/010 (M7x3*)
	3490 3490/300 (M3*)		3490 3490/007 (M10)		3490 3490/003 (MST)
	3490 3490/400 (M4*)		3490 3490/001 (M7x7)		3490 3490/005 (M12x6)
	3490 3490/600 (M6)		3490 3490/011 (M3x3*)		3490 3490/013 (M9x4)
	Gold polished stucco (061)		Silver polished stucco (062)		Gun metal brushed (086)
	Gold brushed (081)		Silver brushed (082)		Gun metal polished (096)
	Gold polished (091)		Silver polished (092)		

\* Stucco effects are not available for this size.



Crystaltex Motives

<<<



65000  
~20x12 mm  
(CO1)  
75%\*



65007  
~18x13 mm  
(CO8)  
75%\*



65017  
~18x11 mm  
(CO18)  
75%\*



65001  
~12x12 mm  
(CO2)  
100%\*



65008  
~33x8 mm  
(CO9)  
65%\*



65018  
~18x11 mm  
(CO19)  
75%\*



65002  
~Ø 20 mm  
(CO3)  
75%\*



65009  
~33x8 mm  
(CO10)  
65%\*



65019  
~19x16 mm  
(CO20)  
75%\*



65003  
~Ø 12 mm  
(CO4)  
75%\*



65011  
~Ø 17 mm  
(CO12)  
75%\*



65023  
~Ø 24 mm  
(CO24)  
75%\*



65004  
~24x12 mm  
(CO5)  
75%\*



65013  
~22x18 mm  
(CO14)  
75%\*



65025  
~21x20 mm  
(CO26)  
75%\*



65005  
~19x14 mm  
(CO6)  
75%\*



65015  
~43x39 mm  
(CO16)  
45%\*



65026  
~Ø 16 mm  
(CO27)  
75%\*



65006  
~14x12 mm  
(CO7)  
75%\*



65016  
~Ø 47 mm  
(CO17)  
45%\*



65027  
~Ø 26 mm  
(CO28)  
75%\*

Transfers



\* Documentation size

Crystaltex Motives Colours of Base Material

<<<



Fabric Silver (F082)



Fabric Antique Silver (F083)



Fabric Gold (F081)



Fabric Antique Gold (F080)



Fabric Black (F012)

Crystaltex Motives Combinations of Base Materials and Colours & Effects

<<<

65 000 to 65 027	Base Material	F012 Fabric Black	F080 Fabric Antique Gold	F081 Fabric Gold	F082 Fabric Silver	F083 Fabric Antique Silver	
	Colour	Crystal (001)	Crystal AB (001 AB)	Crystal Golden Shadow (001 GSHA)	Crystal Silver Shade (001 SSHA)	Jet (280)	Jet Hematite (280 HEM)
	■	■	■	■	■	■	■
	■	■	■	■	■	■	■
	■	■	■	■	■	■	■
	■	■	■	■	■	■	■



Photography: Christoph Sagel, Robert Striegl  
Content is subject to change without notice. Errors and misprints excepted.  
SWAROVSKI AG · P.O. Box 567 · 9495 Triesen · Liechtenstein

© 2010 Swarovski AG. All rights reserved. Partial or total publication, transmission, copy or other duplication of texts, graphics, pictures etc. which are to be found in this publication is forbidden without special consent by Swarovski AG.